

QUADRO

BUILD • CLIMB • DRIVE • SLIDE • SPLASH

EN
DE

ERWEITERUNGEN
EXTENSION KITS
Aufbauanleitung • Construction manual

tested - approved - recommended - worldwide - since 1979



QUADRO

INHALT · CONTENT

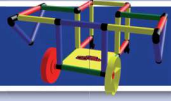

MOBIL3



MOBIL 44

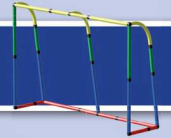

TOR SET · GOAL SET5

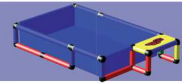

POOL S6



POOL L6

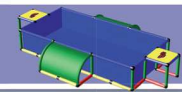

POOL XXL7



BABY BALLCAGE8



BALLCAGE9



SPECIAL KIT (Modell 1 - 5)10



HOME ACTION KIT (Modell 1 - 4)12

Formel • Formula

QUADRO wächst mit Ihrem Kind und ist untereinander vollständig kompatibel sowie beliebig erweiterbar!

QUADRO grows with your child! QUADRO components are fully compatible with each other and can be extended as you like!

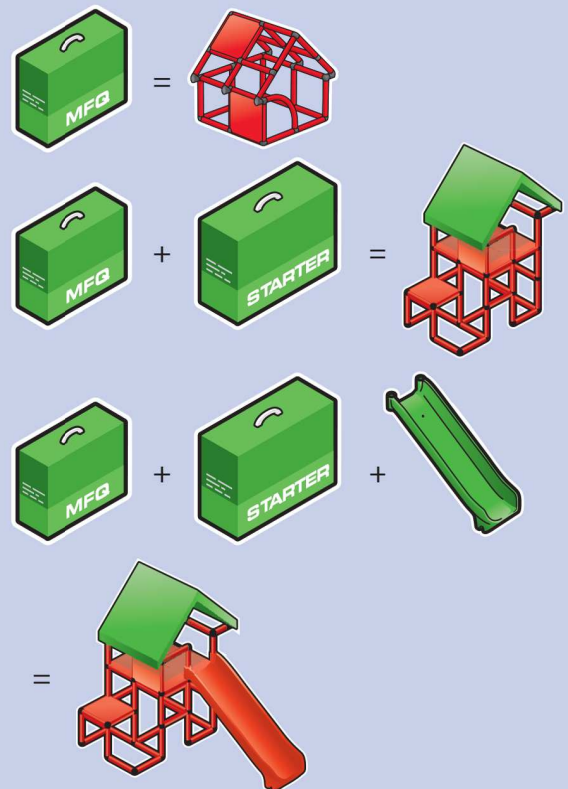

Vorschläge zur Erweiterung Ihres Modells finden Sie in diesem Heft und unter www.quadroworld.com/models, www.quadroworld.com/getcreative und www.quadroworld.com/yougen

Proposals to extend your model you will find in this magazine and on www.quadrworld.com/models, www.quadrworld.com/getcreative and www.quadroworld.com/yougen



ACHTUNG: Vor dem ersten Gebrauch bitte die Sicherheitshinweise (gelbes Heft) sorgfältig durchlesen!
CAUTION: Please read the safety instructions (yellow folder) carefully before you start with assembling!

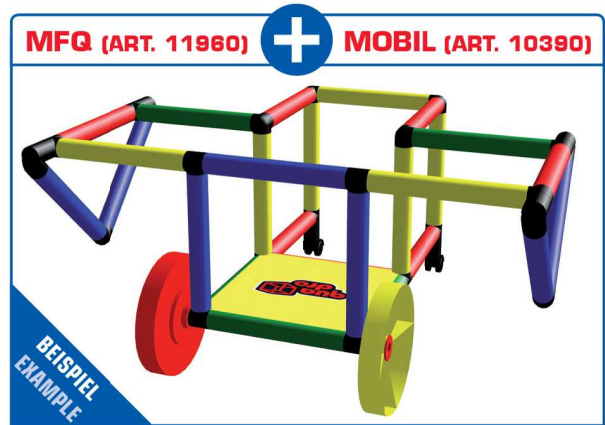
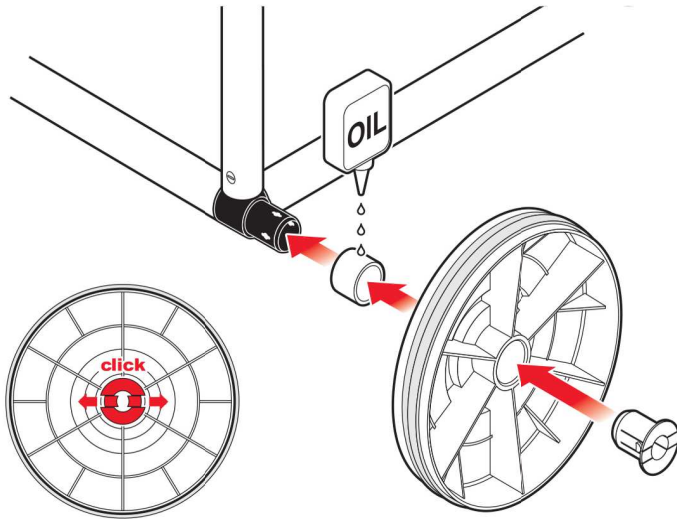

MULTIRAD

Bespannen Sie das QUADRO Multirad vor dem Einbau in das QUADRO Modell mit dem QUADRO Laufreifen für ein besseres und leiseres Abrollverhalten.

TIPP: Um das Bespannen des Multirades mit dem Laufreifen zu erleichtern, erwärmen Sie den Laufreifen vorher in warmem Wasser. Achten Sie darauf, dass sich das QUADRO Multirad bei der Montage in der korrekten Position befindet.

TIPP: Verwenden Sie Schmiermittel zwischen QUADRO Radlager und QUADRO Multirad für ein besseres Laufverhalten.

MULTI-WHEEL

Before assembling the multi-wheel in the QUADRO model, put the tread on the multi-wheel to achieve a smoother and more quiet rolling.

ADVICE: To facilitate the assembling of the tread to the multi-wheel, warm up the tread beforehand in a bit of warm water. Make sure that the QUADRO multi-wheel is in the correct position when assembling it.

ADVICE: Use some grease between the QUADRO bearings and the QUADRO multi-wheel to achieve a better rolling of the wheel.

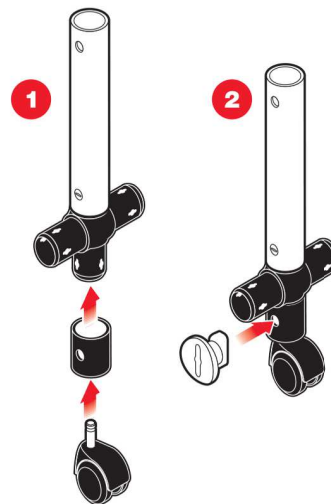

LAUFROLLEN

Die Laufrollen werden mit Hilfe des Adapters und einer Rohrschraube an die dazugehörige Konstruktion montiert.

CASTERS

After connecting caster and adapter with the connector, do not forget to fix the adapter with a screw.

15 Teile • 15 components

Multirad • Multi-wheel	Laufreifen • Tread	Radlager • Bearing	Arretierung • Steering lock	Laufrolle • Roller	Adapter • Adapter	Rohrschraube • Tube screw	Schlüssel • Key
2x Art. : 00852 - 00855	2x Art. : 00895	2x Art. : 00501	2x Art. : 00835	2x Art. : 00451	2x Art. : 00471	2x Art. : 00612- 00615	1x Art. : 00675

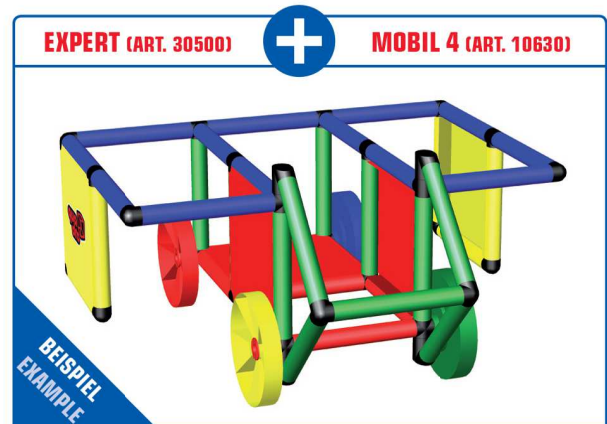

MULTIRAD

Bespannen Sie das QUADRO Multirad vor dem Einbau in das QUADRO Modell mit dem QUADRO Laufreifen für ein besseres und leiseres Abrollverhalten.

TIPP: Um das Bespannen des Multirades mit dem Laufreifen zu erleichtern, erwärmen Sie den Laufreifen vorher in warmem Wasser. Achten Sie darauf, dass sich das QUADRO Multirad bei der Montage in der korrekten Position befindet.

TIPP: Verwenden Sie Schmiermittel zwischen QUADRO Radlager und QUADRO Multirad für ein besseres Laufverhalten.

MULTI-WHEEL

Before assembling the multi-wheel in the QUADRO model, put the tread on the multi-wheel to achieve a smoother and more quiet rolling.

ADVICE: To facilitate the assembling of the tread to the multi-wheel, warm up the tread beforehand in a bit of warm water. Make sure that the QUADRO multi-wheel is in the correct position when assembling it.

ADVICE: Use some grease between the QUADRO bearings and the QUADRO multi-wheel to achieve a better rolling of the wheel.

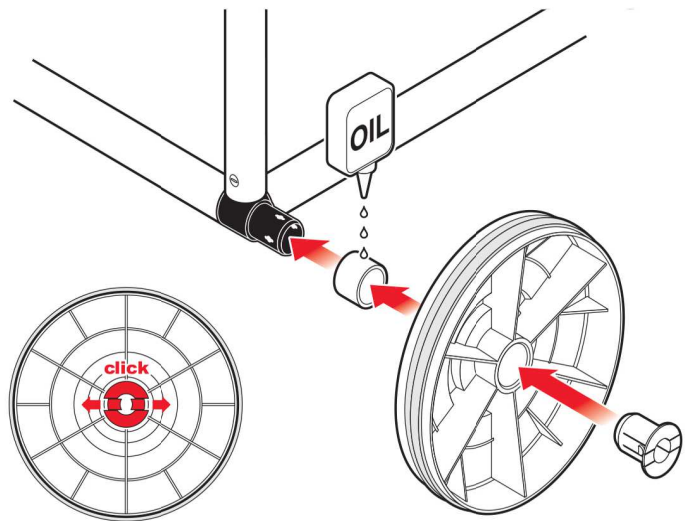

16 Teile • 16 components

Multirad • Multi-wheel	Laufreifen • Tread	Radlager • Bearing	Arretierung • Steering lock
4x Art. : 00852 - 00855	4x Art. : 00895	4x Art. : 00501	4x Art. : 00835

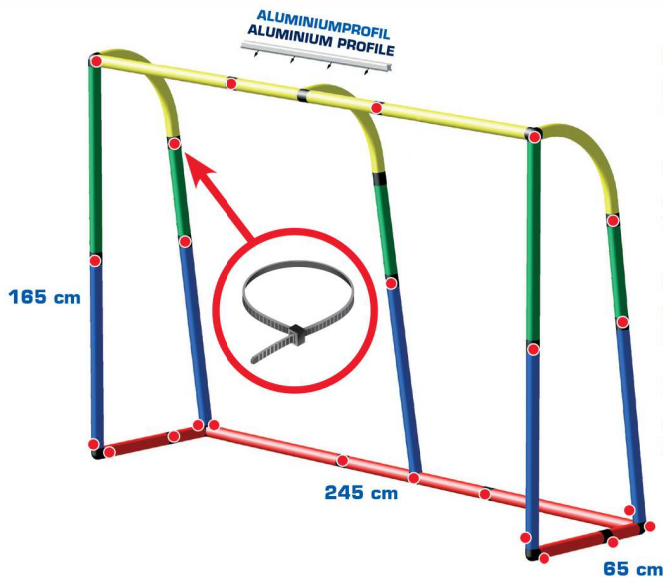

KABELBINDER

Befestigen Sie alle Kabelbinder gleichmäßig an der Außenseite des Tores um das Tornetz zu fixieren.

CABLE STRAPS

Connect all cable straps equally to the outer part of the goal to be able to attach the net on the exterior of the goal.

FLÜGELSCHRAUBE

Eine alternative Methode, um das Tornetz zu befestigen, finden Sie in den Sicherheitshinweisen auf Seite 6, 1.12.

NETCLIP

An alternative method to fix the goal net you can find in the Safety Instructions on page 6, 1.12.

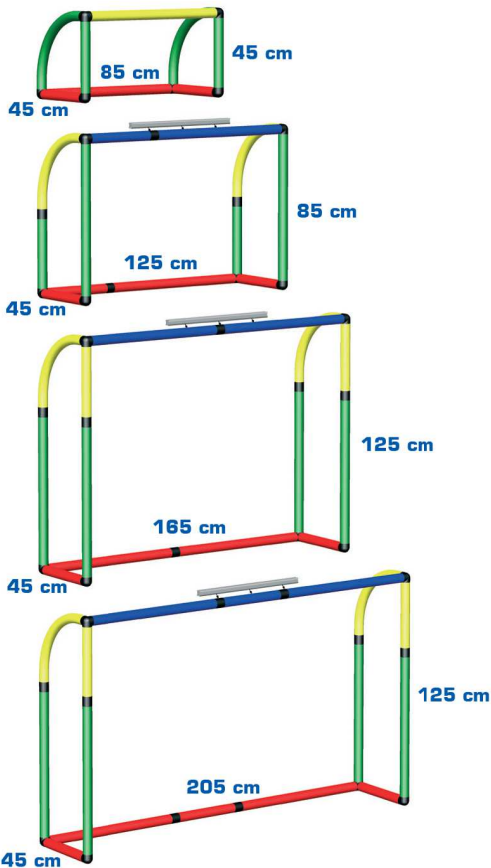

BODENVERANKERUNG

Sie können das Tor auch im Boden verankern. Hierzu befolgen Sie bitte die Bauweise, wie in Abb. 1 oder 2 dargestellt. Hinweise wie die Bodenverankerung eingebaut wird, finden Sie auch in den Sicherheitshinweisen auf Seite 13, 5.1.

TIPP: Die Bodenverankerung passt für jede Torgröße!

ANCHORING TO THE GROUND

You can also attach the goal to the ground. Therefore please assemble the model as shown in figure 1 or 2. For more information please take a look into the Safety Instructions on page 13, 5.1

HINT: The anchoring is suitable for every goal size!

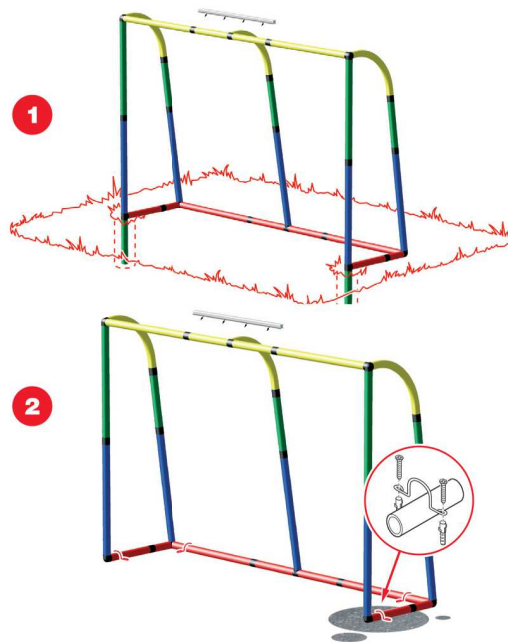

132 Teile • 132 components

<p>Raumk. 3-armig 3 way connector</p>  <p>4x Art. : 00031</p>	<p>Flächenk. 3-armig T connector</p>  <p>4x Art. : 00131</p>	<p>Rohr (15 cm) • Tube (15 cm)</p>  <p>2x Art. : 00512 - 00515</p>	<p>Bogenrohr • Curved tube</p>  <p>3x Art. : 10052 - 10055</p>	<p>24 Kabelbinder • 24 Cable straps</p>  <p>1x Tüte/Bag Art. : 00666</p>	<p>Tornetz Net for goal</p>  <p>1x Art. : 10223</p>	<p>Schlüssel • Key</p>  <p>1x Art. : 00675</p>
<p>E.k. 2-armig (90°) Elbow connector</p>  <p>2x Art. : 00121</p>	<p>E.k. 2-armig (180°) 2 way connector</p>  <p>14x Art. : 00111</p>	<p>Rohr (35 cm) • Tube (35 cm)</p>  <p>11x Art. : 00532 - 00535</p>	<p>Rohr (75 cm) • Tube (75 cm)</p>  <p>11x Art. : 00372 - 00575</p>	<p>Alu-Profil (75 cm) Alu profile (75 cm)</p>  <p>1x Art. : 40276</p>	<p>Rohrschraube • Tube screw</p>  <p>54x Art. : 00612- 00615</p>	

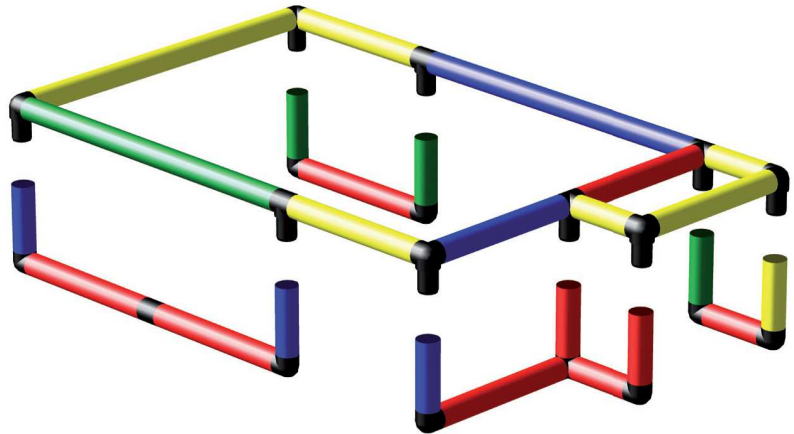
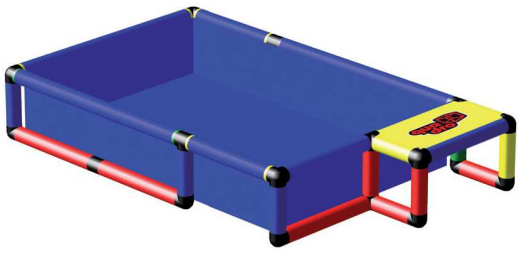

POOL KLEIN











Wasserhöhe max.: 20 cm

POOL SMALL

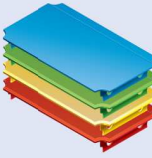
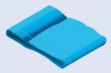
Water level max.: 20 cm

L/B/H • LW/H:
145 cm x 85 cm x 25 cm

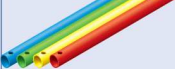
105 Teile • 105 components

<p>Raumk. 4-armig 4 way connector</p>  <p>2x Art. : 00041</p>	<p>Raumk. 3-armig 3 way connector</p>  <p>6x Art. : 00031</p>	<p>F.k. 2-armig (180°) 2 way connector</p>  <p>1x Art. : 00111</p>	<p>Rohr (35 cm) Tube (35 cm)</p>  <p>9x Art. : 00532 - 00535</p>	<p>Platte (40 x 20 cm) Panel (40 x 20 cm)</p>  <p>1x Art. : 00202 - 00205</p>	<p>Poolfolie klein Pool foil small</p>  <p>1x Art. : 10012</p>	<p>Schlüssel Key</p>  <p>3x Art. : 00675</p>
<p>Flächenk. 3-armig T connector</p>  <p>2x Art. : 00131</p>	<p>Flächenk. 2-armig (90°) Elbow connector</p>  <p>8x Art. : 00121</p>	<p>Rohr (15 cm) Tube (15 cm)</p>  <p>13x Art. : 00512 - 00515</p>	<p>Rohr (75 cm) • Tube (75 cm)</p>  <p>3x Art. : 00572 - 00575</p>	<p>Plattenschraube Panel screw</p>  <p>6x Art. : 00620</p>	<p>Rohrschraube Tube screw</p>  <p>50x Art. : 00612- 00615</p>	

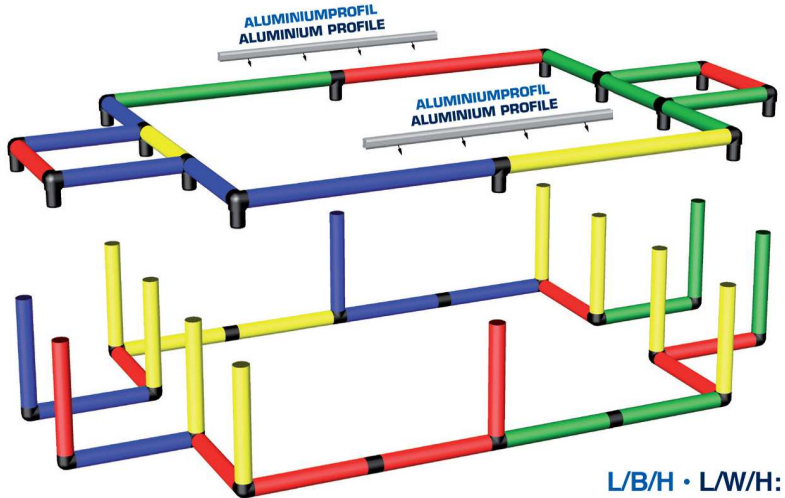

POOL GROSS

Wasserhöhe max.: 35 cm
Befüllbar mit max. 2000 St. Bälle Ø 60 mm (4x Art. 12600)

POOL LARGE

Water level max.: 35 cm
Fillable with max. 2000 pcs. Balls Ø 60 mm (4x Art.12600)

L/B/H • LW/H:
245 cm x 125 cm x 45 cm

186 Teile • 186 components

<p>Raumk. 4-armig 4 way connector</p>  <p>4x Art. : 00041</p>	<p>Raumk. 3-armig 3 way connector</p>  <p>16x Art. : 00031</p>	<p>F.k. 2-armig (180°) 2 way connector</p>  <p>4x Art. : 00111</p>	<p>Rohr (35 cm) • Tube (35 cm)</p>  <p>42x Art. : 00532 - 00535</p>	<p>Platte (40 x 40 cm) Panel (40 x 40 cm)</p>  <p>2x Art. : 00402 - 00405</p>	<p>Poolfolie groß Pool foil large</p>  <p>1x Art. : 10022</p>	<p>Schlüssel • Key</p>  <p>3x Art. : 00675</p>
<p>Flächenk. 3-armig T connector</p>  <p>4x Art. : 00131</p>	<p>Flächenk. 2-armig (90°) Elbow connector</p>  <p>4x Art. : 00121</p>	<p>Rohr (75 cm) • Tube (75 cm)</p>  <p>4x Art. : 00572 - 00575</p>	<p>Alu-Profil (75 cm) Alu profile (75 cm)</p>  <p>2x Art. : 40276</p>	<p>Plattenschraube Panel screw</p>  <p>8x Art. : 00620</p>	<p>Rohrschraube • Tube screw</p>  <p>92x Art. : 00612- 00615</p>	

INFO

ALUMINIUMPROFIL

Mehr Informationen über die Aluminiumprofile & Aluminium-profil-Verbinder finden Sie in den Sicherheitshinweisen auf Seite 6, 1.13

ALUMINIUM PROFILE

You can find more information about the aluminium profile & aluminium profile connector in the Safety Instructions on page 6, 1.13

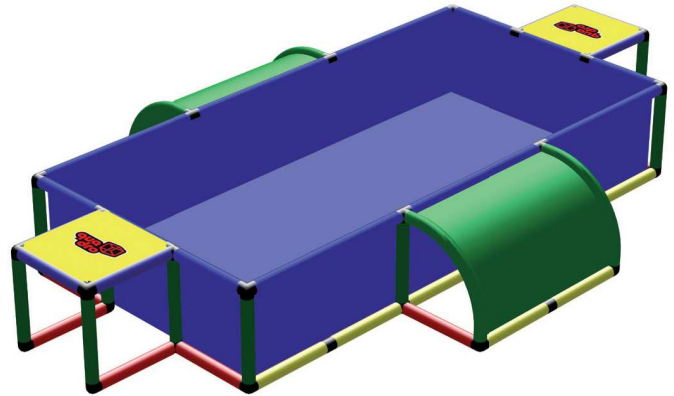

POOL XXL

Wasserhöhe max.: 35 cm
Befüllbar mit max. 3000 St. Bälle Ø 60 mm (6x Art. 12600)

POOL XXL



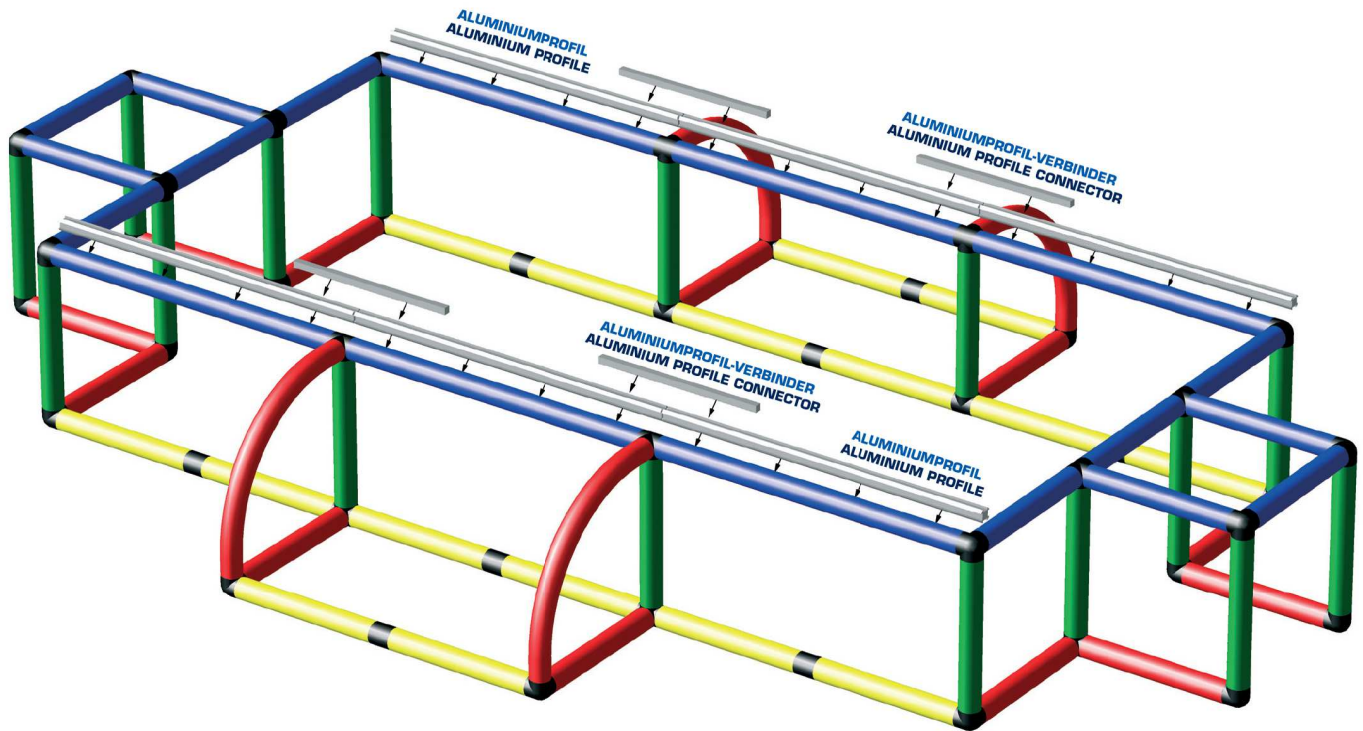









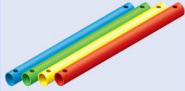

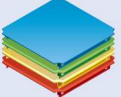
Water level max.: 35 cm
Fillable with max. 3000 pcs. Balls Ø 60 mm (6x Art.12600)



L/B/H • L/W/H:

325 cm x 125 cm x 45 cm

268 Teile • 268 components

<p>Raumk. 4-armig 4 way connector</p>  <p>12x Art. : 00041</p>	<p>E.k. 2-armig (90°) Elbow connector</p>  <p>4x Art. : 00121</p>	<p>Rohr (75 cm) • Tube (75 cm)</p>  <p>6x Art. : 00572 - 00575</p>	<p>Rohr (35 cm) • Tube (35 cm)</p>  <p>56x Art. : 00532 - 00535</p>	<p>Platte Panel (40 x 40 cm)</p>  <p>2x Art. : 00402 - 00405</p>	<p>Poolfolie XXL Pool foil XXL</p>  <p>1x Art. : 10032</p>	<p>Rundtextil Round textile</p>  <p>2x Art. : 00363</p>	<p>Schlüssel • Key</p>  <p>3x Art. : 00675</p>
<p>Raumk. 3-armig 3 way connector</p>  <p>20x Art. : 00031</p>	<p>E.k. 2-armig (180°) 2 way connector</p>  <p>8x Art. : 00111</p>	<p>Bogenrohr • Curved tube</p>  <p>4x Art. : 10052 - 10055</p>	<p>Alu-Profil (75 cm) Alu profile (75 cm)</p>  <p>6x Art. : 40276</p>	<p>Alu-Profil-Verbinder Alu profile connector</p>  <p>4x Art. : 40274</p>	<p>Plattenschraube Panel screw</p>  <p>8x Art. : 00620</p>	<p>Rohrschraube Tube screw</p>  <p>132x Art. : 00612- 00615</p>	

BABY BALLCAGE

HINWEIS: Für den Baby Ballcage benötigen Sie den Pool Klein.

BABY BALLCAGE

ADVICE: To assemble the baby ballcage a small pool is required.

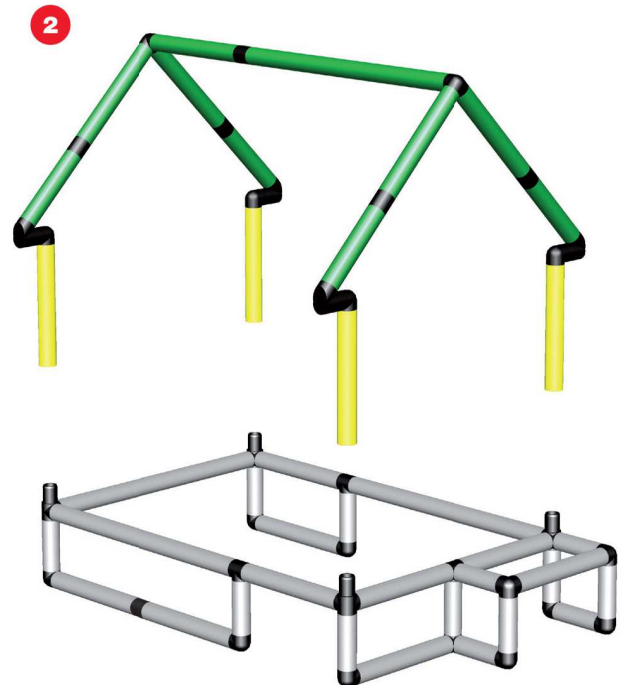
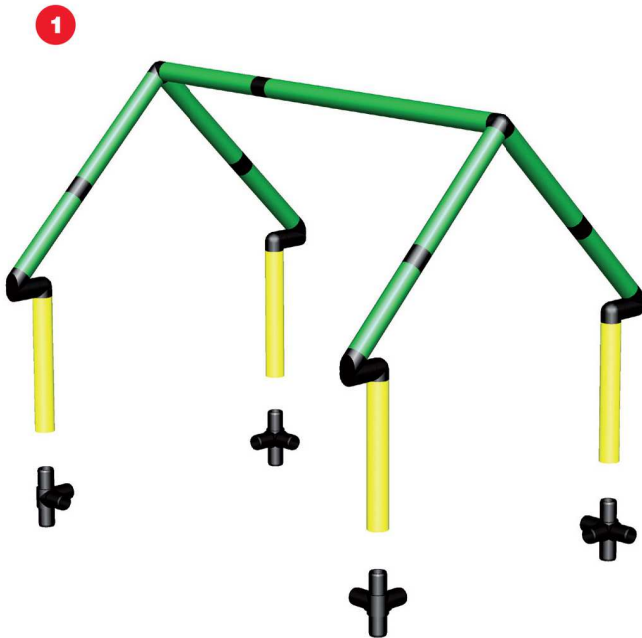
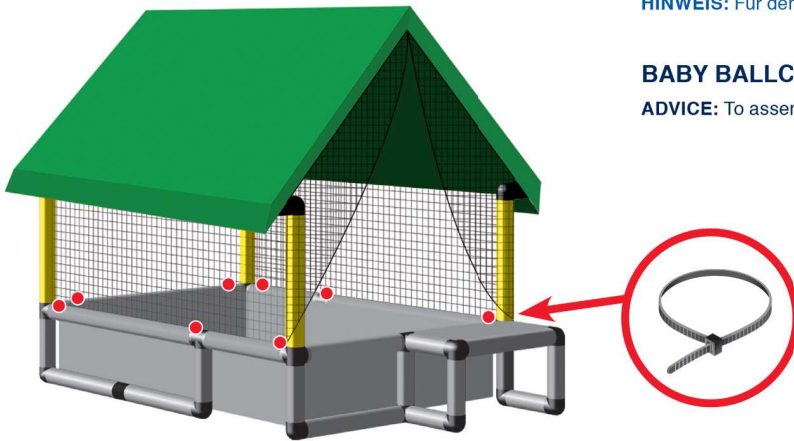

L/B/H · L/W/H:

145 x 99 x 105 cm

90 Teile · 90 components

Raumk. 5-armig 5 way connector  1x Art. : 00051	Raumk. 4-armig 4 way connector  3x Art. : 00041	Raumk. 3-armig 3 way connector  2x Art. : 00031	Rohr (25 cm) Tube (25 cm)  4x Art. : 00522 - 00525	24 Kabelbinder 24 Cable straps  1x Tüte • Bag Art. : 00666	Netz (Baby Ballcage) Net (baby ballcage)  1x Art. : 10232	Dachtextil (Baby Ballcage) Roof textile (baby ballcage)  1x Art. : 00011	Rohrschraube Tube screw  28x Art. : 00612- 00615
Ek. 2-armig (90°) Elbow connector  4x Art. : 00121	Ek. 2-armig (180°) 2 way connector  5x Art. : 00111	Winkelk. (45°) Diagonal connector  4x Art. : 00911	Rohr (35 cm) Tube (35 cm)  9x Art. : 00532 - 00535	Rohr (75 cm) Tube (75 cm)  1x Art. : 00572 - 00575	Schlüssel Key  3x Art. : 00675		



BALLCAGE

HINWEIS: Für den Ballcage benötigen Sie den Pool Groß.

BALLCAGE

ADVICE: To assemble the ballcage a large pool is required.

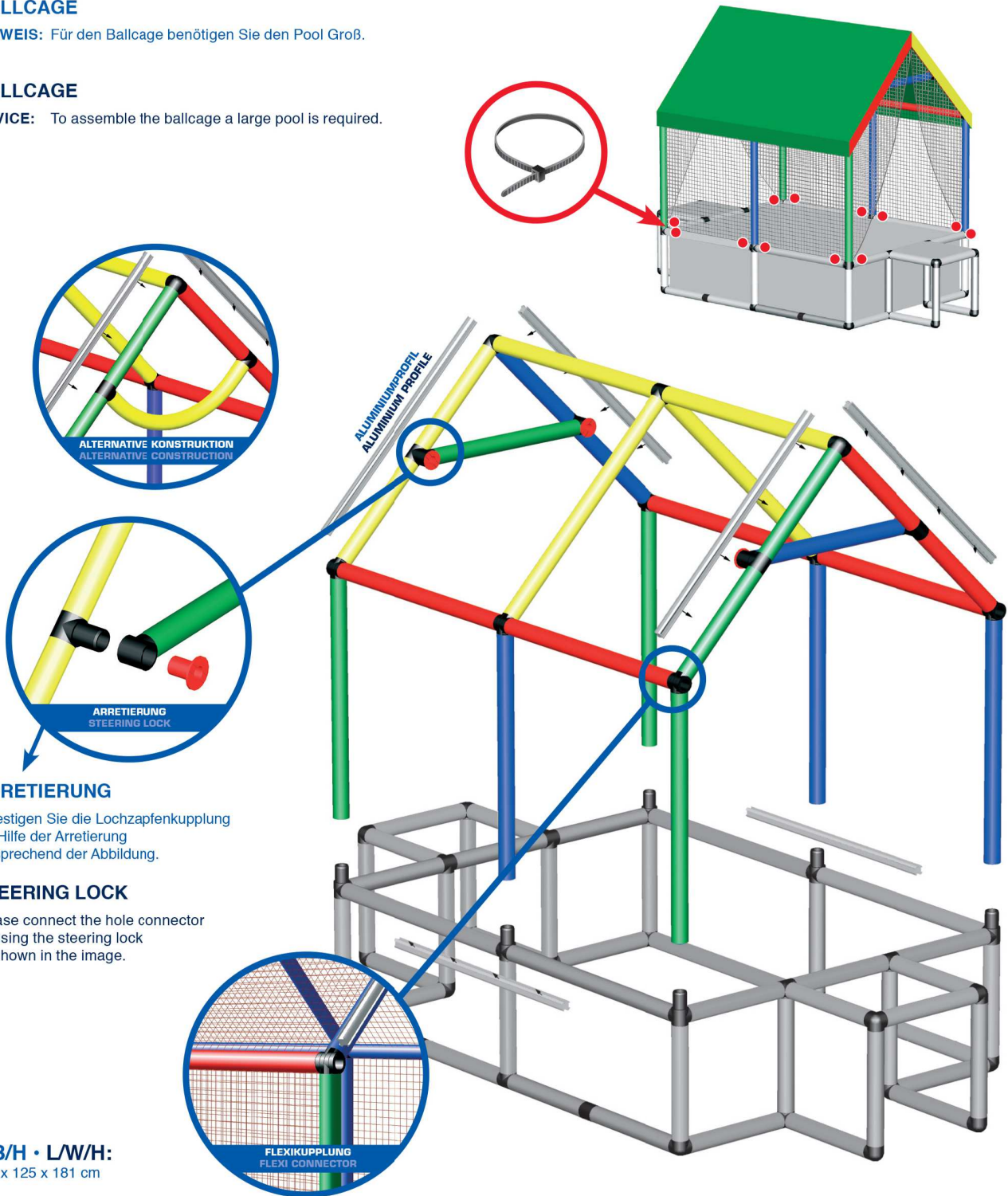

ARRETIERUNG









Befestigen Sie die Lochzapfenkupplung mit Hilfe der Arretierung entsprechend der Abbildung.

STEERING LOCK

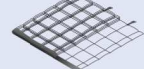
Please connect the hole connector by using the steering lock as shown in the image.

L/B/H · L/W/H:
245 x 125 x 181 cm

130 Teile · 130 components

Raumk. 4-armig 4 way connector  5x Art. : 00041	Raumk. 3-armig 3 way connector  2x Art. : 00031	Flexikupplung Flexi connector  6x Art. : 00071	Rohr (35 cm) Tube (35 cm)  8x Art. : 00532 - 00535	Alu-Profil (75 cm) Alu profile (75 cm)  4x Art. : 40276	Netz (Ballcage) Net (ballcage)  1x Art. : 10233	Rohrschraube Tube screw  48x Art. : 00612- 00615	Arretierung Steering lock  4x Art. : 00835
Flächenk. 4-armig Cross connector  2x Art. : 00141	Flächenk. 3-armig T connector  4x Art. : 00131	Lochzapfenk. Hole connector  4x Art. : 00841	Rohr (75 cm) Tube (75 cm)  14x Art. : 00572 - 00575	Rohr (52 cm) Tube (52 cm)  2x Art. : 40522 - 40525	Dachtextil (Ballcage) Roof textile (ballcage)  1x Art. : 00010	24 Kabelbinder 24 Cable straps  1x Tüte = Bag Art. : 00666	Schlüssel Key  1x Art. : 00675

37 Teile • 37 components

<p>Raumk. 4-armig • 4 way connector</p>  <p>2x Art. : 00041</p>	<p>Winkelk. (45°) • Diagonal connector</p>  <p>4x Art. : 00911</p>	<p>Rohr (15 cm) • Tube (15 cm)</p>  <p>6x Art. : 00512 - 00515</p>	<p>Bogenrohr • Curved tube</p>  <p>2x Art. : 10052 - 10055</p>	<p>Schlüssel • Key</p>  <p>1x Art. : 00675</p>
<p>E.k. 2-armig (90°) • Elbow connector</p>  <p>2x Art. : 00121</p>	<p>Rohrschraube • Tube screw</p>  <p>20x Art. : 00612- 00615</p>			

MODELLVORSCHLAG 1 (Schlitten) • MODEL PROPOSAL 1 (Sledge)

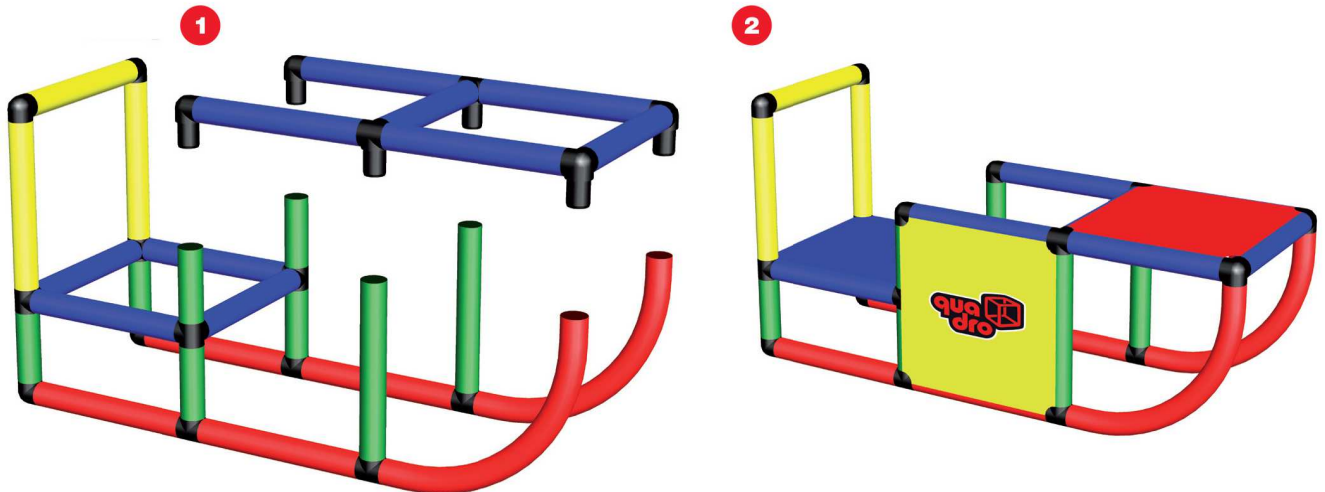

SPECIAL KIT + STARTER (Art. 12840)

L/B/H • L/W/H:
125 x 45 x 65 cm

MODELLVORSCHLAG 2 (Tisch + Stuhl) MODEL PROPOSAL 2 (Table + Chair)

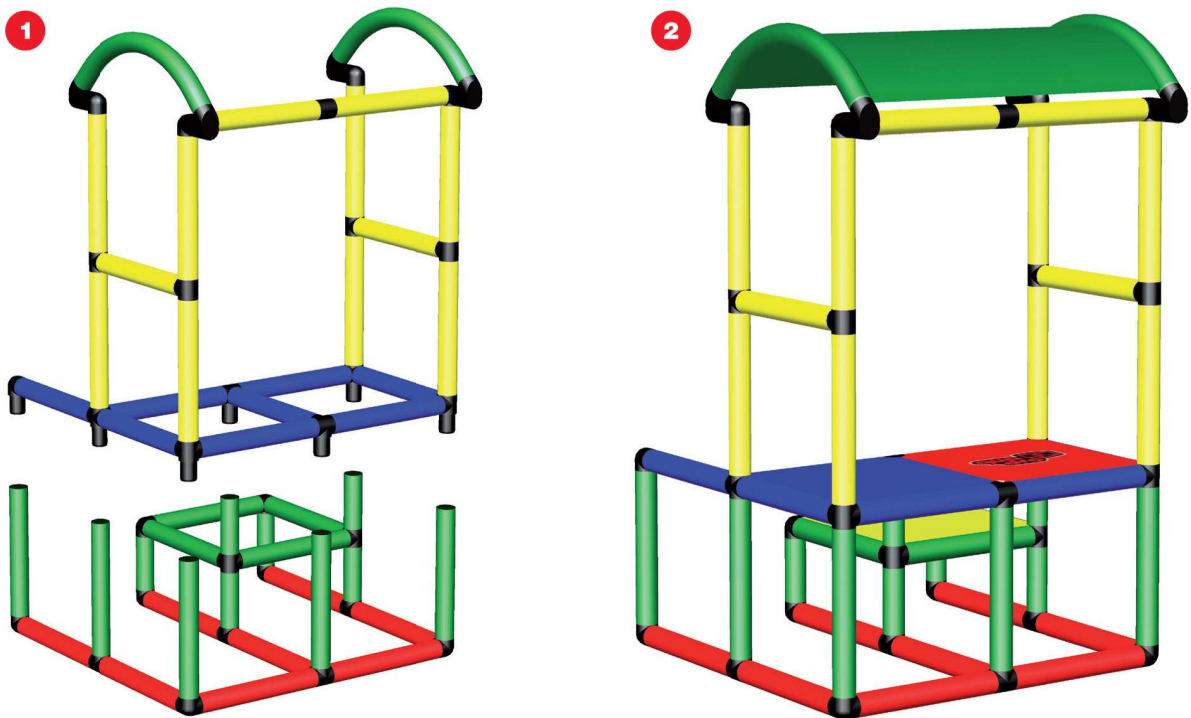

SPECIAL KIT + STARTER (Art. 12840)

L/B/H • L/W/H:
92 x 85 x 142 cm

MODELLVORSCHLAG 3 (Haus) • MODEL PROPOSAL 3 (House)

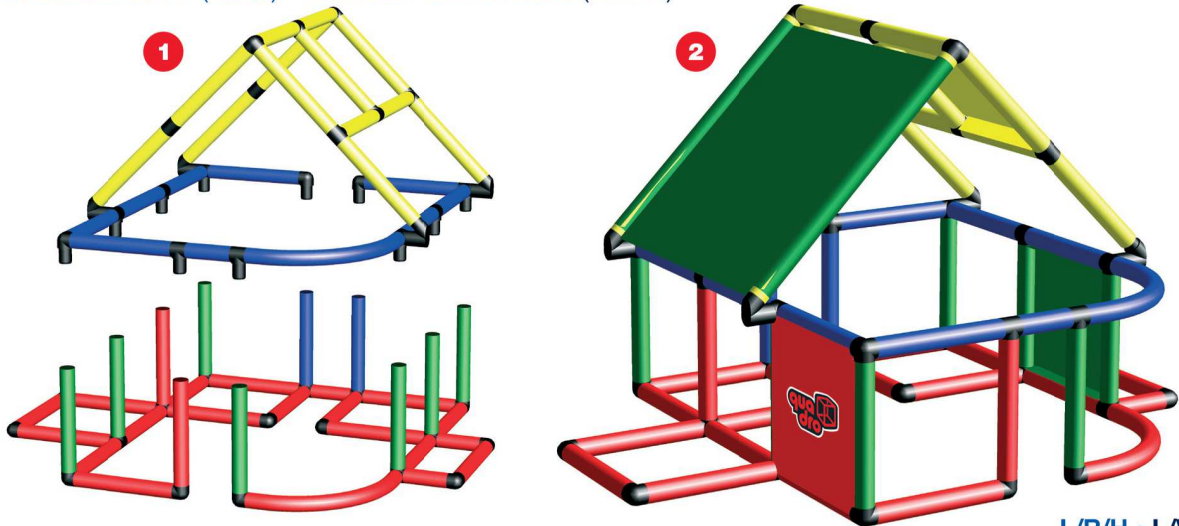

SPECIAL KIT + STARTER (Art. 12840)

L/B/H • L/W/H:
165 x 125 x 103 cm

MODELLVORSCHLAG 4 (Theater + Stuhl) • MODEL PROPOSAL 4 (Theatre + chair)

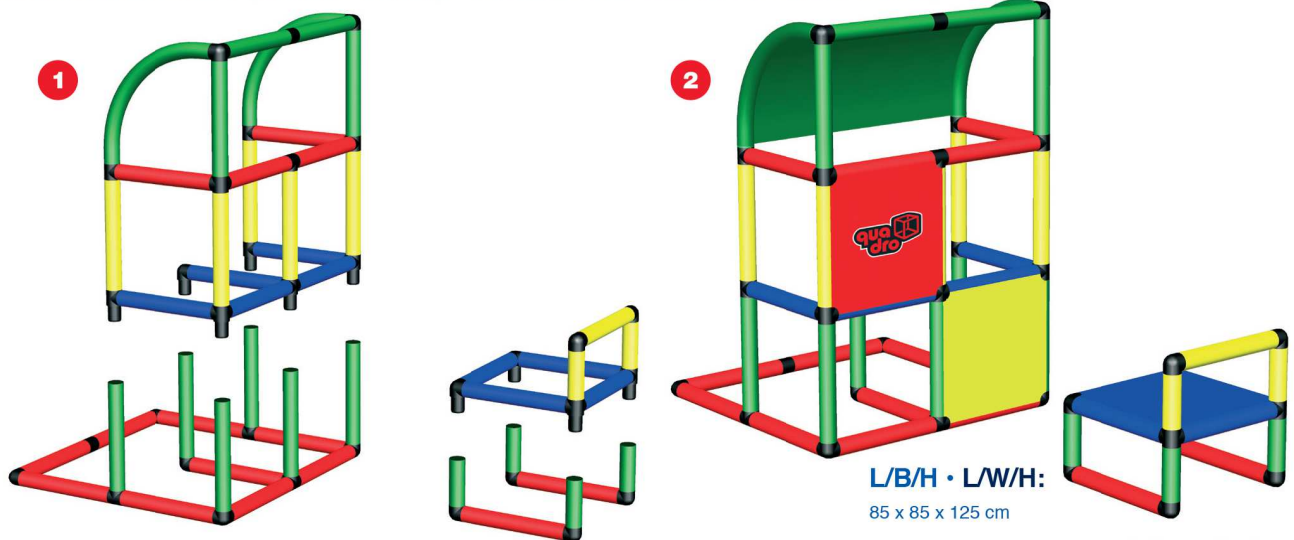

SPECIAL KIT + STARTER (Art. 12840)

L/B/H • L/W/H:
85 x 85 x 125 cm









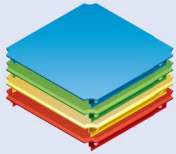

L/B/H • L/W/H:
45 x 45 x 45 cm

MODELLVORSCHLAG 5 (Tor) • MODEL PROPOSAL 5 (Goal)

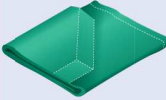
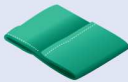

SPECIAL KIT + STARTER (Art. 12840)

L/B/H • L/W/H:
85 x 45 x 85 cm

67 Teile • 67 components						
Raumk. 4-armig 4 way connector  2x Art. : 00041	E.k. 2-armig (180°) 2 way connector  3x Art. : 00111	Platte • Panel (40 x 40 cm)  9x Art. : 00402 - 00405	Rohr (15 cm) • Tube (15 cm)  3x Art. : 00512 - 00515	Dachtextil Roof textile  1x Art. : 00353	Spielsack Play bag  1x Art. : 00383	Rohrschraube Tube screw  6x Art. : 00612- 00615
Flächenk. 4-armig Cross connector  1x Art. : 00141	Winkelk. (45°) Diagonal connector  4x Art. : 00911		Plattenschraube • Panel screw  36x Art. : 00620			Schlüssel Key  1x Art. : 00675

HOME ACTION KIT

Der Spielsack muss während des Aufbaus des Grundgerüsts montiert werden (siehe Sicherheitsbroschüre Seite 8, 1.17). Bitte beachten Sie, dass das Modell erst nach der Montage der Platten verschraubt werden darf. Achten Sie beim Einbau der Platten unbedingt auf die Ausrichtung der Schraublöcher! Die Schraublöcher müssen sich jeweils an den Enden der rot-weißen Markierungen befinden (siehe Sicherheitsbroschüre Seite 4, 1.3). Montieren Sie zum Abschluss das Textil-Dach (siehe Sicherheitsbroschüre Seite 8, 1.15)

HOME ACTION KIT

The Play bag has to be installed during the construction of the model (see Safety Instructions page 8, 1.17). Please note that the model has to be screwed only after the assembly of the panels. While installing the panels please make sure that the screw holes of the tubes correspond with the screw holes of the panels. Consider always the correct position of the panels. The red/white marking shows the position of the screw holes (see Safety Instructions page 4, 1.3). Finally install the roof textile (see Safety Instructions page 8, 1.15).

MODELLVORSCHLAG 1 (Haus) • MODEL PROPOSAL 1 (House)

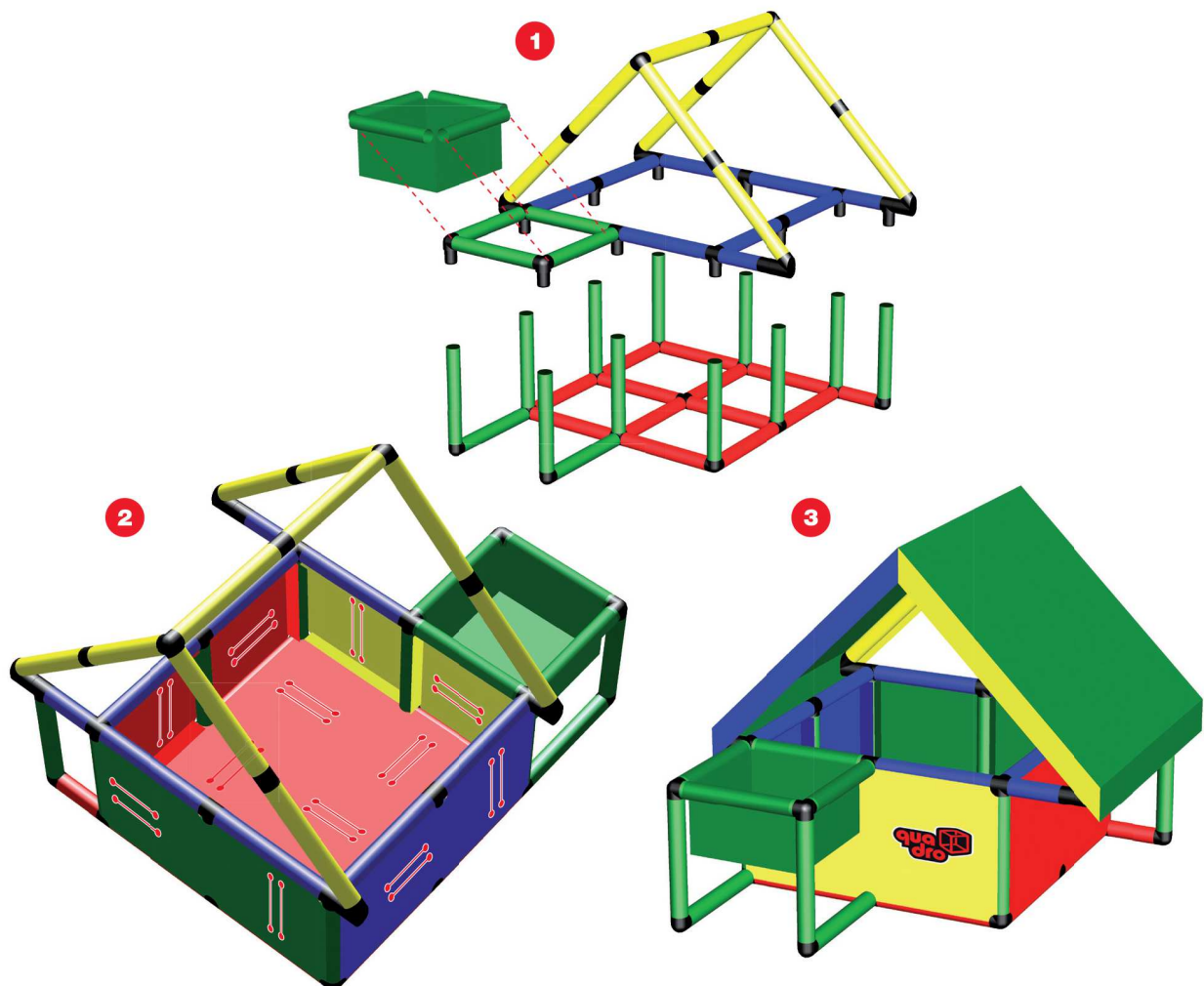

HOME ACTION KIT + STARTER (Art. 12840)

L/B/H • L/W/H:
119 x 125 x 103 cm

MODELLVORSCHLAG 2 (Haus + Tunnel) • MODEL PROPOSAL 2 (House + tunnel)

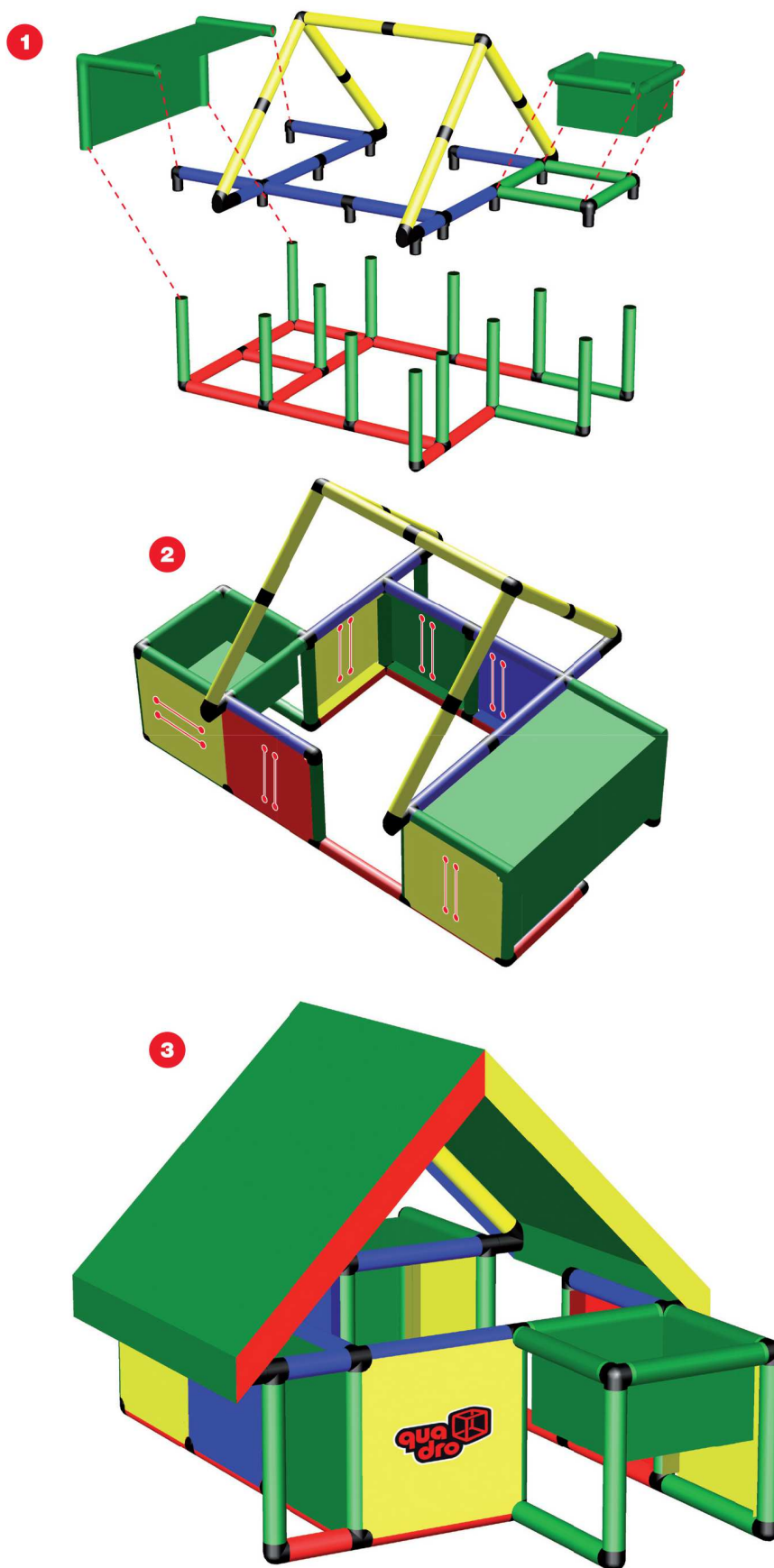

HOME ACTION KIT + STARTER (Art. 12840)

L/B/H • L/W/H:
165 x 119 x 103 cm

MODELLVORSCHLAG 3 (Haus) • MODEL PROPOSAL 3 (House)

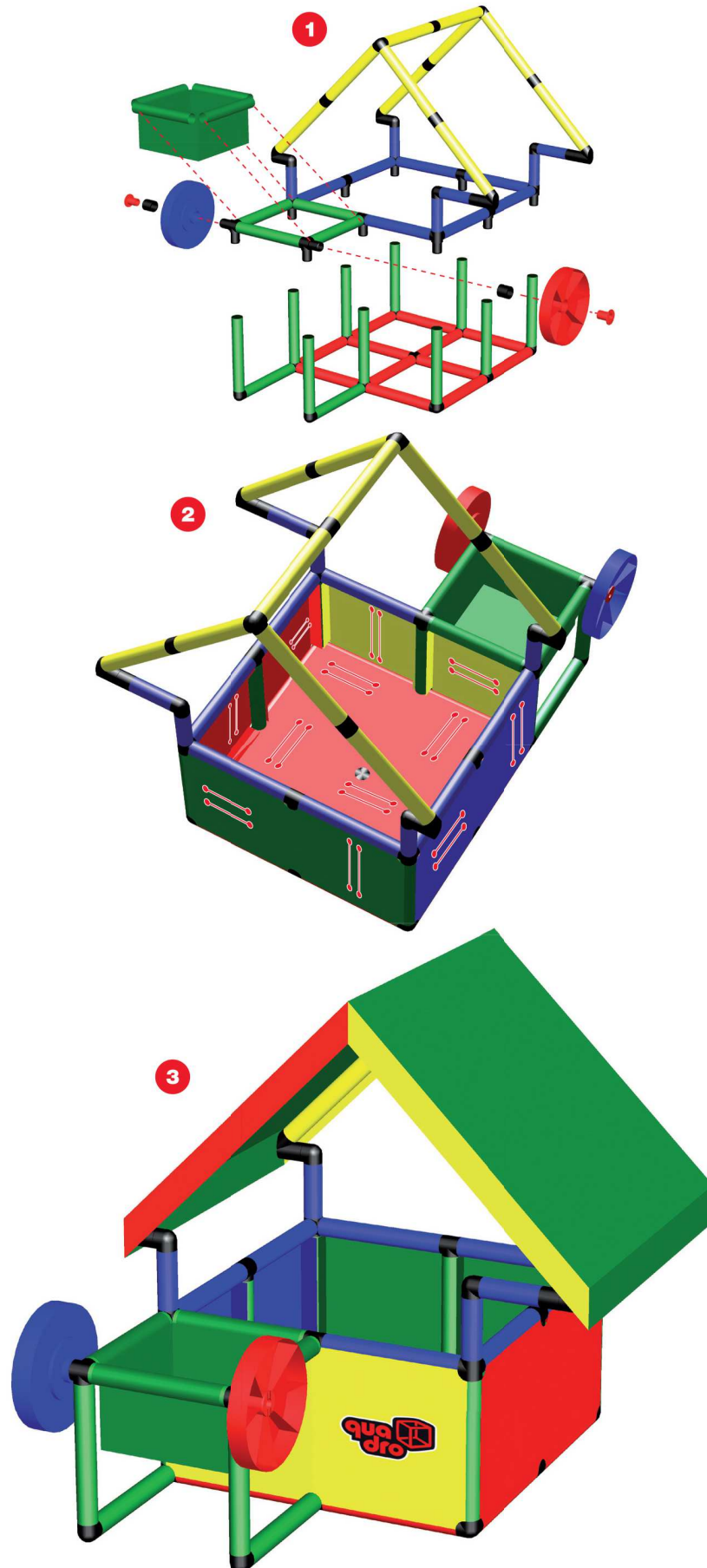

HOME ACTION KIT + BASIC (Art. 13120)

L/B/H • LW/H:
139 x 119 x 123 cm

MODELLVORSCHLAG 4 (Haus + Auto) • MODEL PROPOSAL 4 (House + car)



L/B/H • L/W/H:
172 x 125 x 143 cm

L/B/H • L/W/H:
99 x 59 x 99 cm

HOME ACTION KIT + UNIVERSAL (Art. 14830) + MOBIL (Art. 10390)

QUADRO

BUILD • CLIMB • DRIVE • SLIDE • SPLASH

+ KOMBINATION



QUADRO DER GROSSBAUKASTEN

Buxtehuder Str. 112 | 21073 Hamburg | Germany
Tel. +49 40 79 00 50 80 | Fax +49 40 52 98 23 32

info@quadroworld.com | www.quadroworld.com



für/for: QUADRO STANDARD



© 1979-2017 by QUADRO DER GROSSBAUKASTEN Ltd.
Company Number 5383292. All rights reserved.

v. 1.6 DE/EN